

THIRD ANGLE PROJECTION

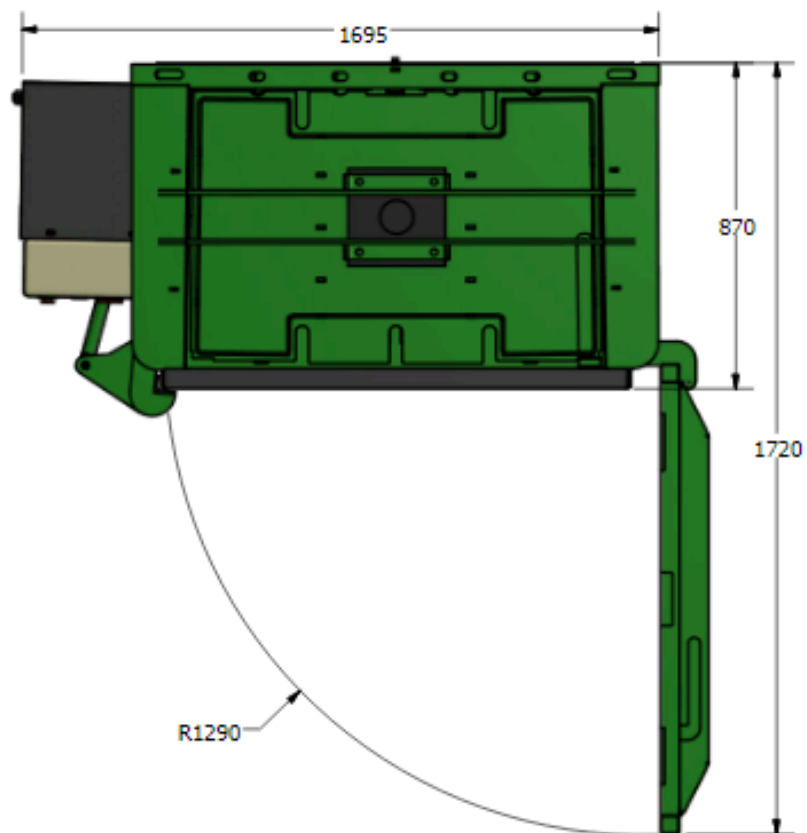
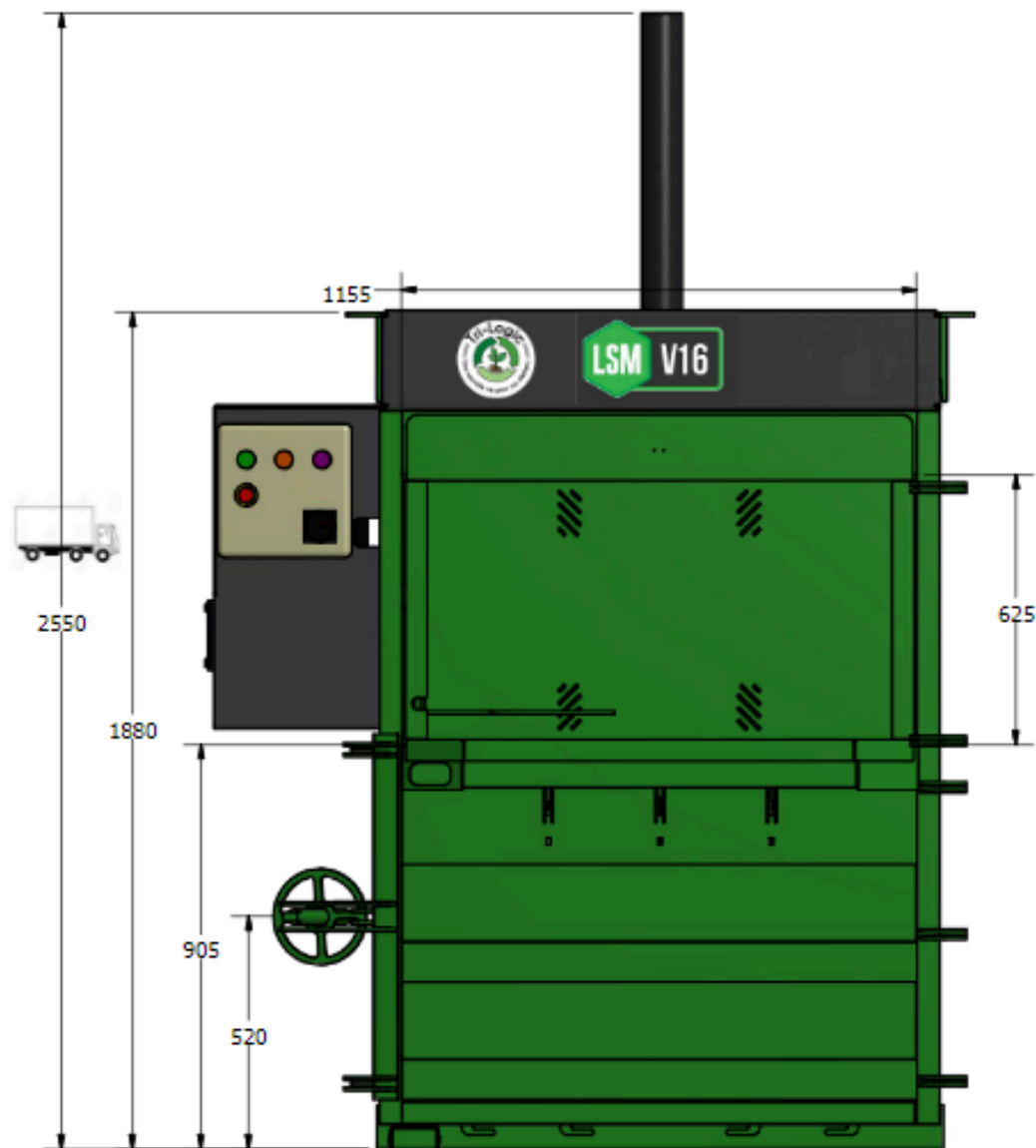
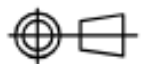

WWW.TRI-LOGIC.FR

MODEL CODE	V16
MACHINE WEIGHT	950 Kg
NOISE LEVEL	74 dB