

THIRD ANGLE PROJECTION

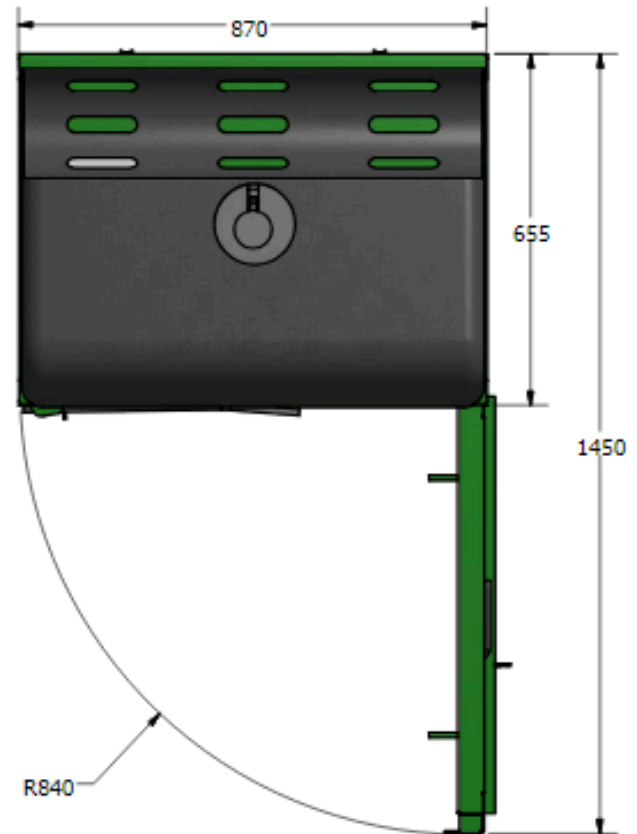
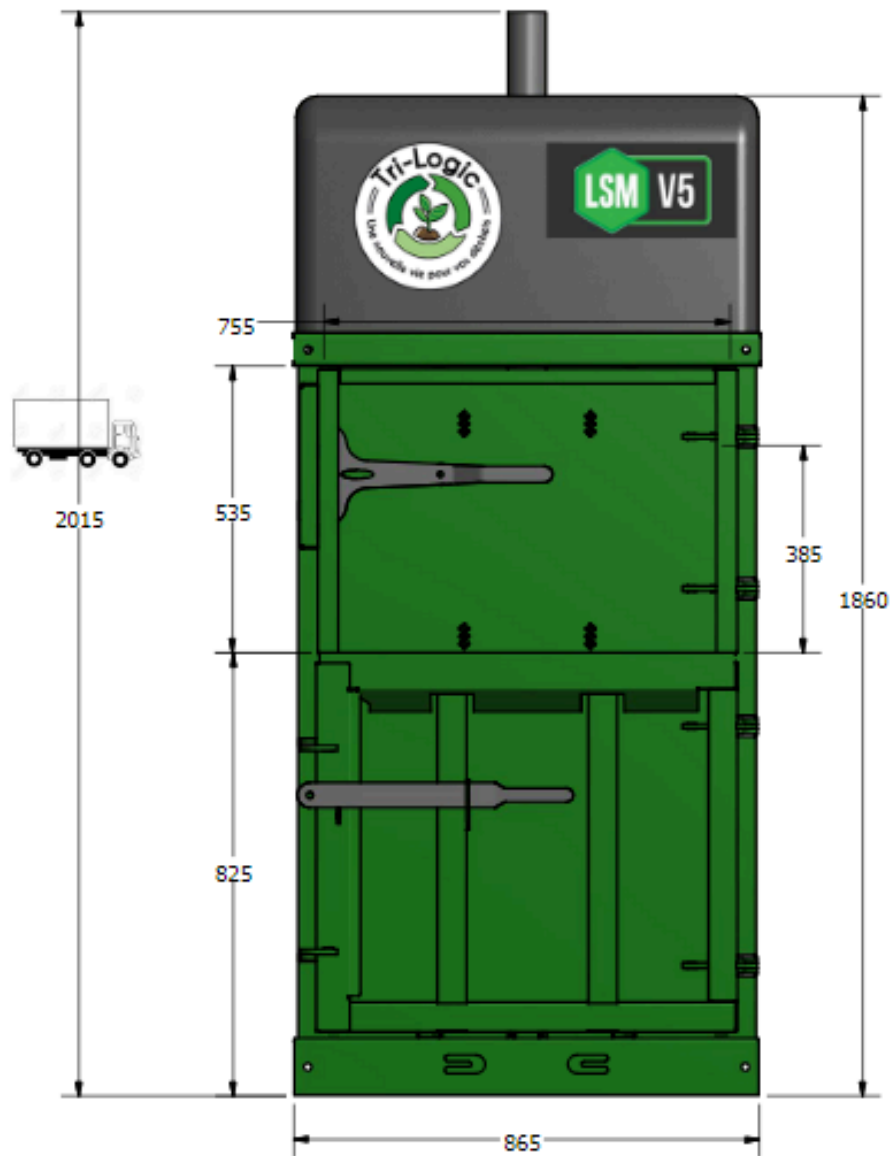

WWW.TRI-LOGIC.FR

MODEL CODE	V5
MACHINE WEIGHT	340 KG
NOISE LEVEL	70 dB